

COURSE	GRAPHIC COMMUNICATION	NAME	
LEVEL	NATIONAL 5	DATE	17/02/2023
SCHOOL		SCALE	INDIVIDUAL SCALES
UNIT	FINAL ASSESSMENT	DRAWING	ORTHOGRAPHIC
TASK NAME	TASK 1A	ALL SIZES IN MILLIMETRES	

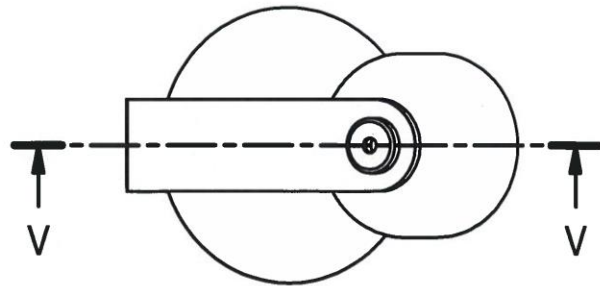

V-V (1:3)

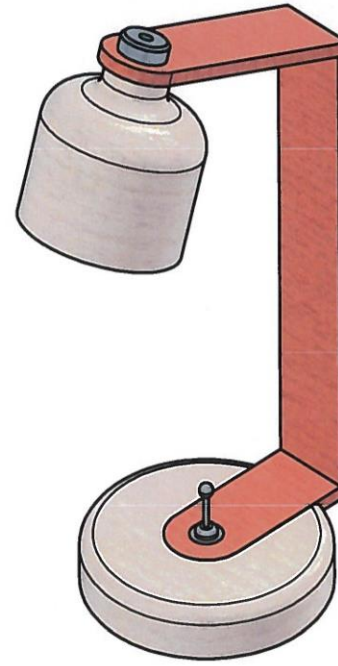

PICTORIAL ISOMETRIC VIEW

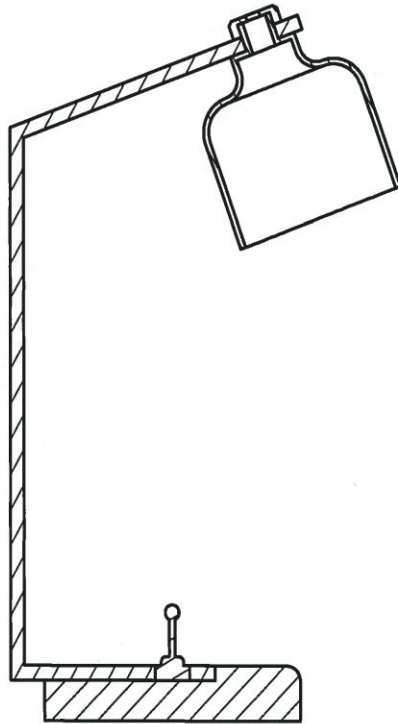

SECTIONAL FRONT ELEVATION

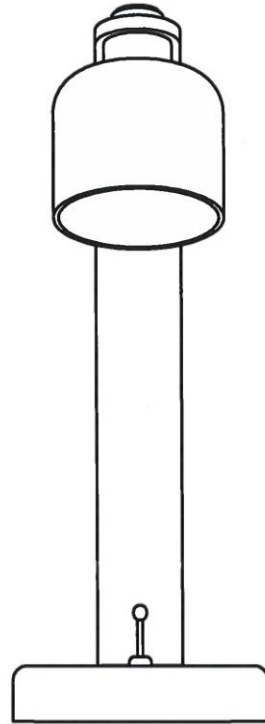

END ELEVATION

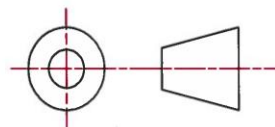

COURSE	GRAPHIC COMMUNICATION	NAME	
LEVEL	NATIONAL 5	DATE	21/2/23
SCHOOL		SCALE	1:3
UNIT	DESK LAMP	DRAWING	ORTHOGRAPHIC
TASK NAME	TASK 1B	ALL SIZES IN MILLIMETRES	

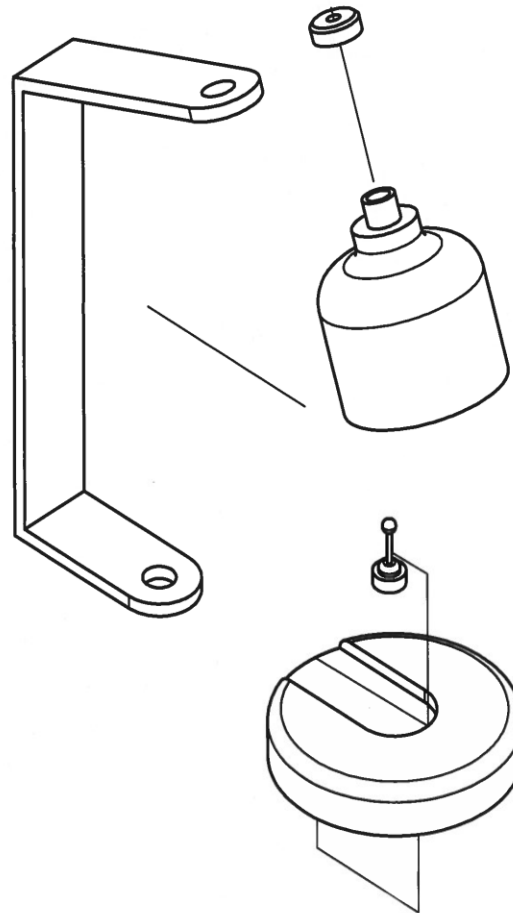

EXPLODED ISOMETRIC VIEW

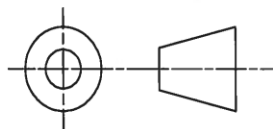

COURSE	GRAPHIC COMMUNICATION	NAME	
LEVEL	NATIONAL 5	DATE	22/02/23
SCHOOL		SCALE	1:3
UNIT	DESK LAMP	DRAWING	ISOMETRIC
TASK NAME	TASK 1C	ALL SIZES IN MILLIMETRES	

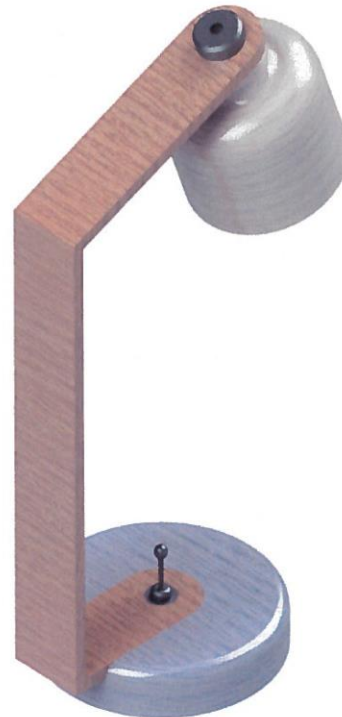
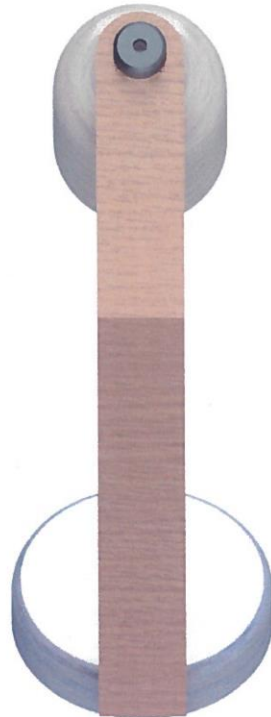
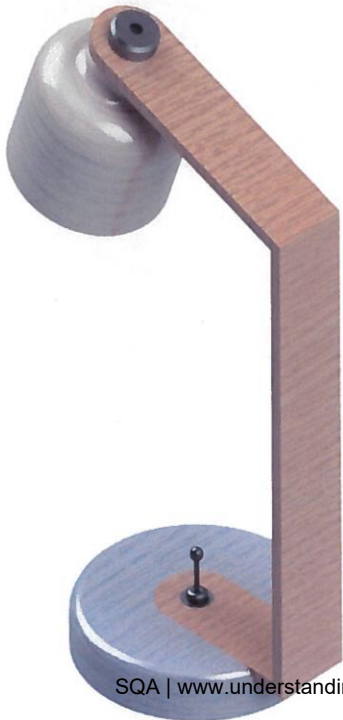
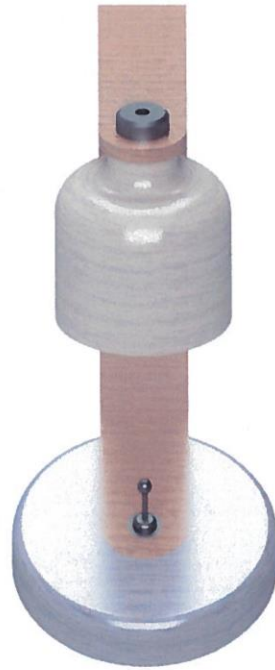
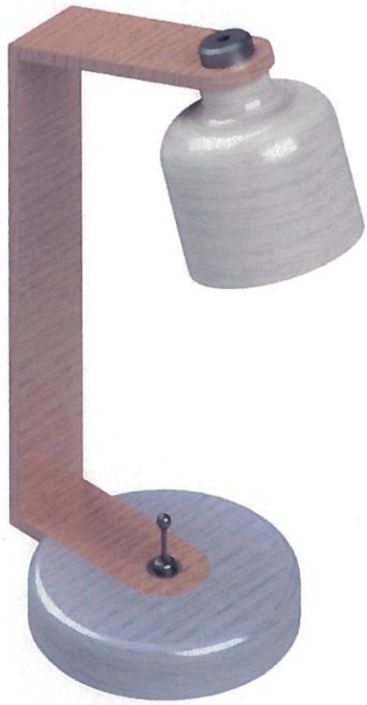

White space

Brown
- modernist impact

yellow
Lively mood

for depth depth

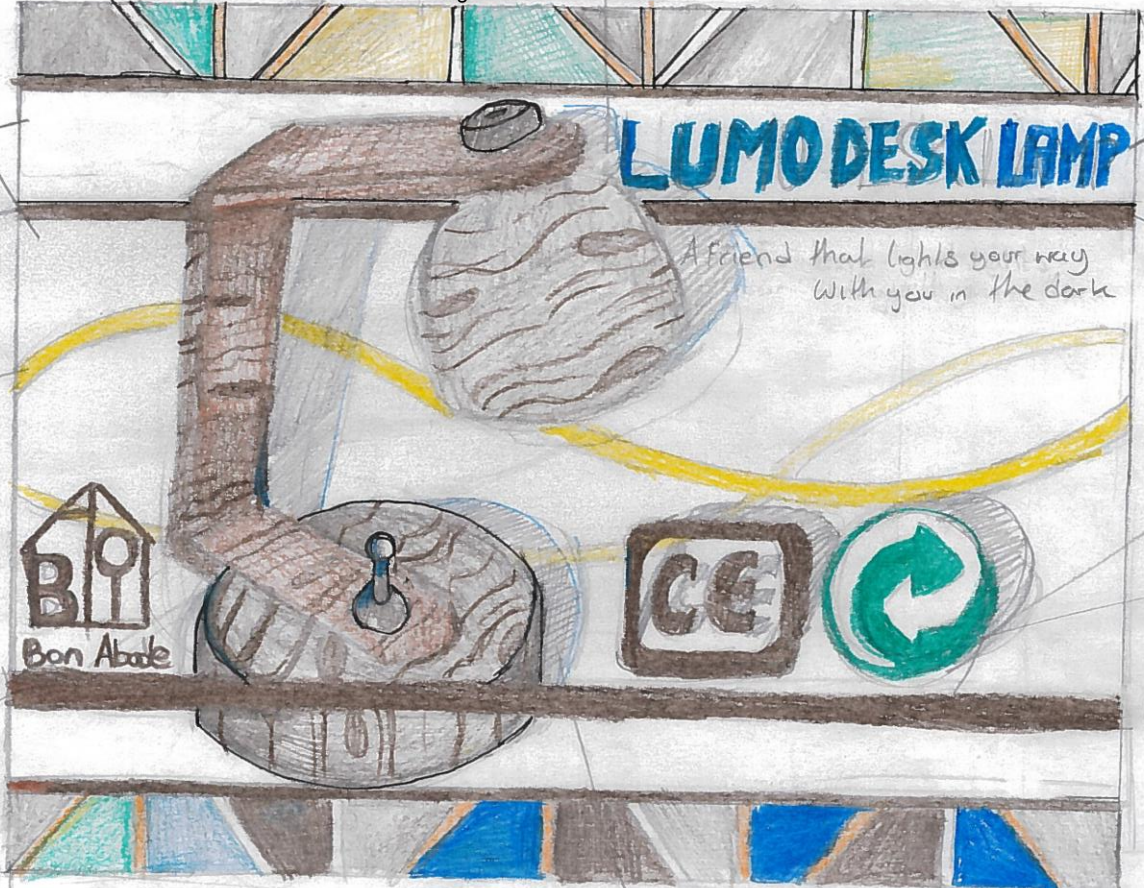

LUMODESK LAMP

A friend that lights your way With you in the dark

text aligned to left side.

depth passes through under lamp.

aligned with logo's

depth

White space

Lamp creates dominance by its size SHADOW depth



LUMODESK LAMP

Font change to create contrast

line behind memory stick creates depth

Transparency

yellow energy

depth line over the object

colour green safety

Dominance

reduced background colour to make the object stand out

Enlarged object compared to the symbols cause dominance

contrast

different fonts

underline to create emphasis to title

contrast caps to lower case

Text aligned to the left

yellow + green creates Harmony

Added white space to make object stand out

Yellow

Creates a lively mood + energy

Brown
makes the ad more modern feeling

symbols that are aligned to the line, makes ad more organized



CLOCK BASE (1.2)

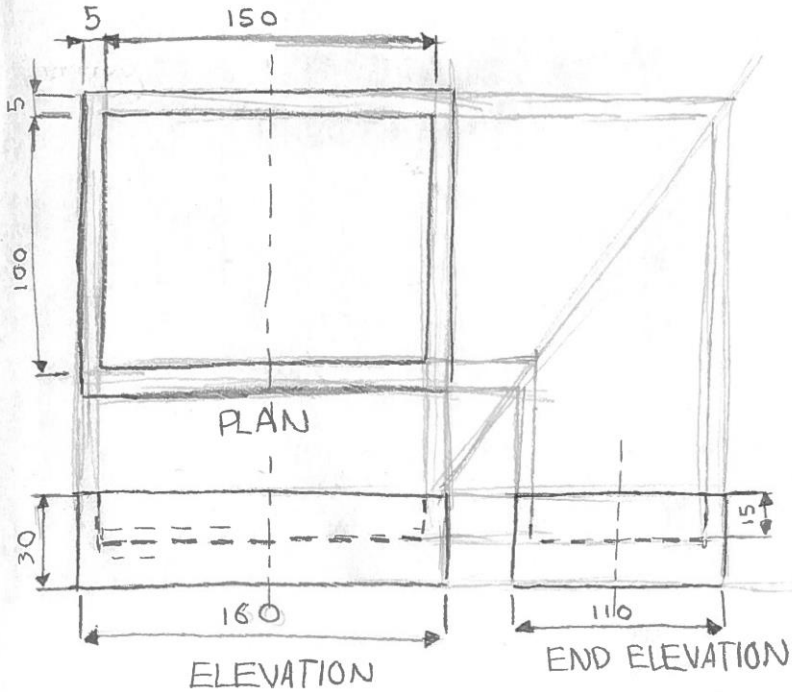

CLOCK STAND (1.3)

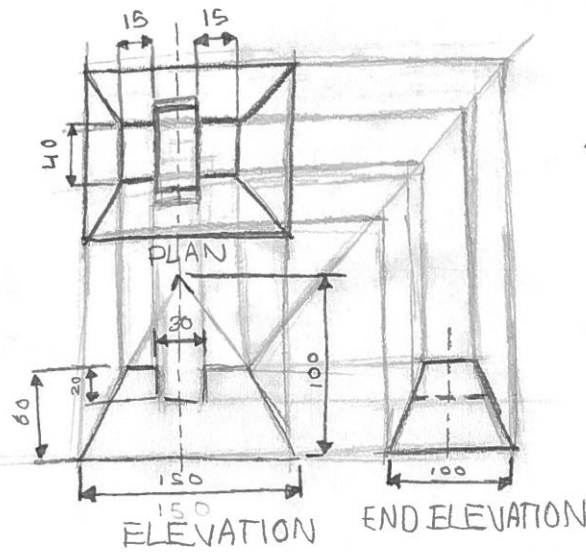

CLOCK TOP (1.2)

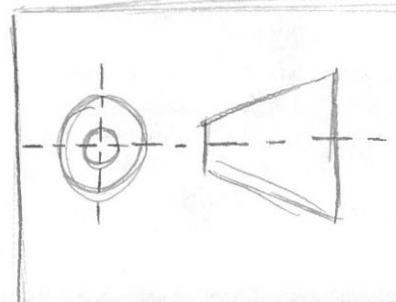
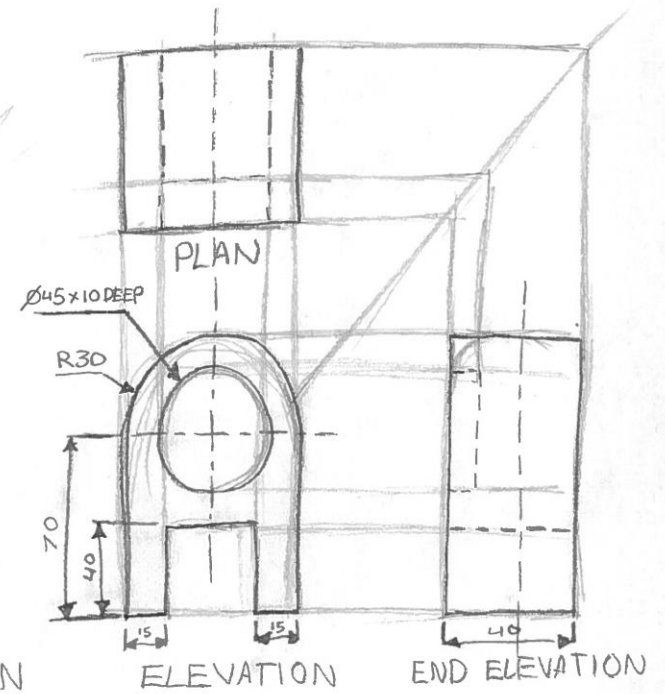

COURSE	Graphic communication	NAME	
LEVEL	NATIONALS	DATE	10/03/23
SCHOOL		SCALE	INDIVIDUAL SCALES
UNIT	DESK CLOCK	DRAWING	7 of 8 ORTHOGRAPHIC
TASK NAME	3A		ALL SIZES IN MILLIMETRES

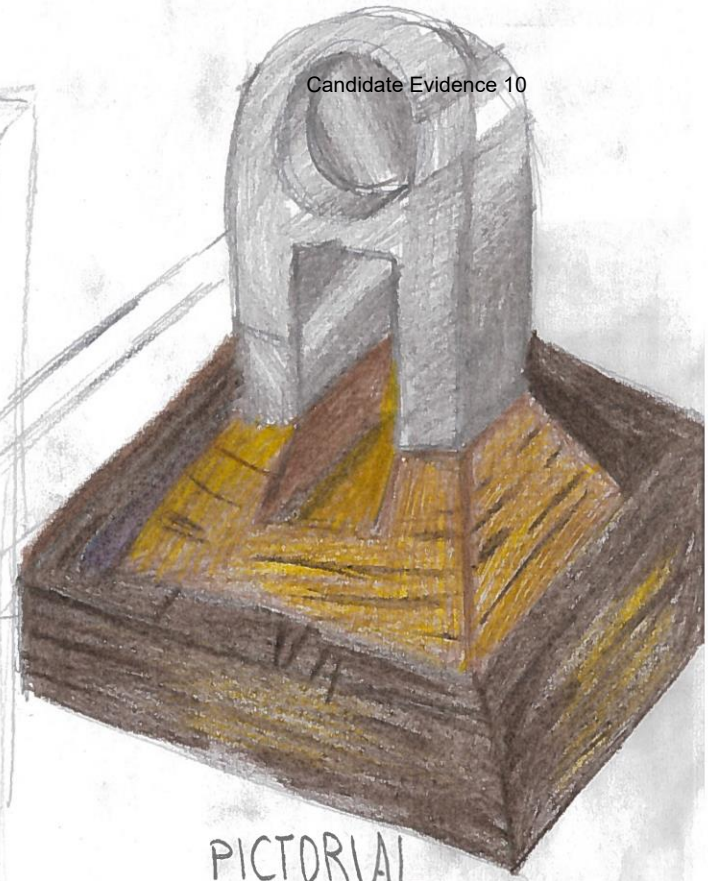
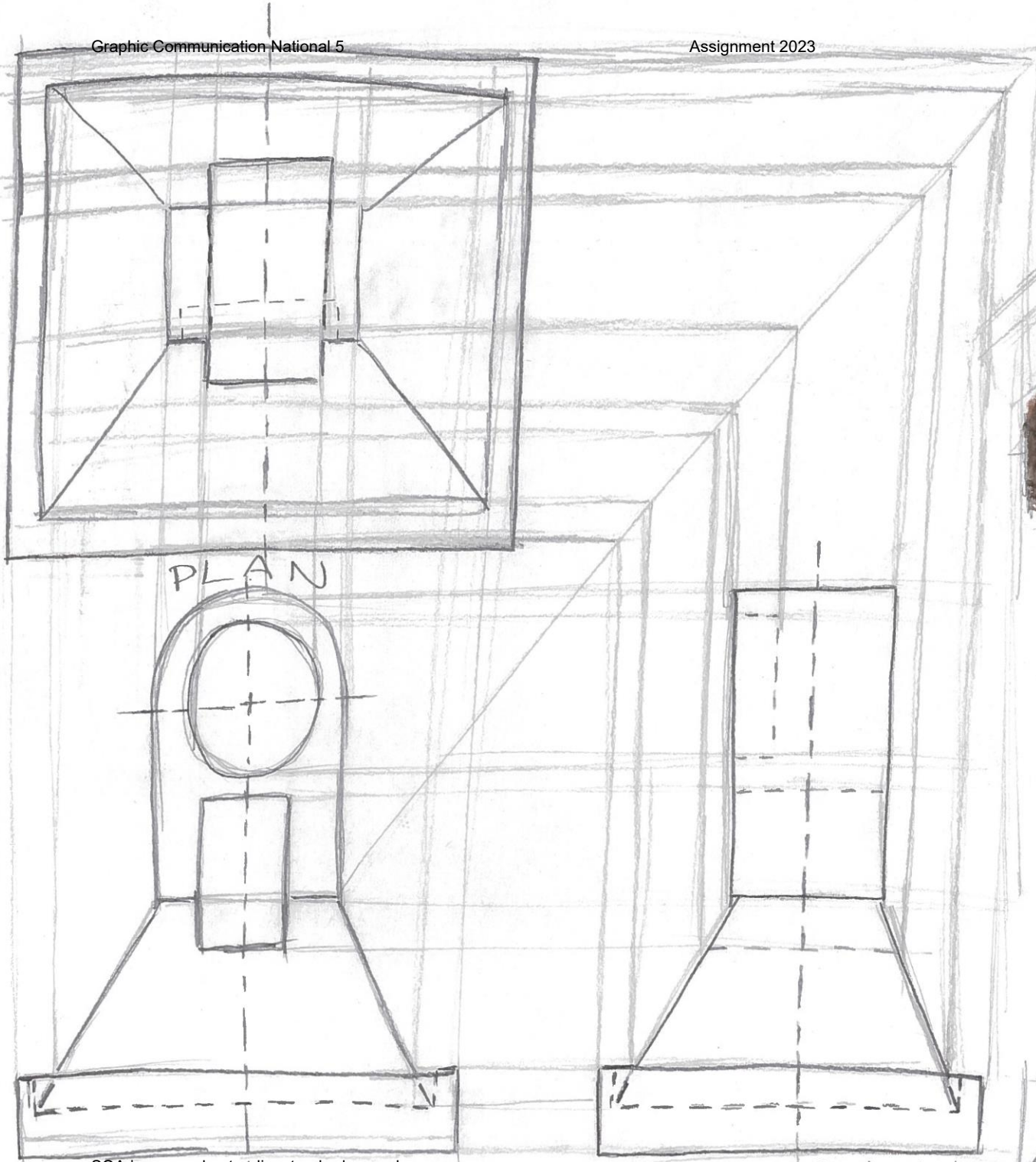

PICTORIAL ISOMETRIC

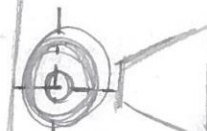

COURSE	GRAPHIC COMMUNICATION	NAME	
LEVEL	NATIONAL 5	DATE	13/03/22
SCHOOL		SCALE	1:2
UNIT	DESK CLOCK	DRAWING	ORTHOGRAPHICAL